

X-Ray Tube Specifications

Maximum Peak Voltage	225 kV	Temperature at fluid inlet (maximum)	35°C
Focal Spot EN12543		Cooling Medium	Water
Small	D = 1.0 mm	Reference Axis	Perpendicular to port face.
Large	D = 3.0 mm	Radiation Coverage	40°
Focal Spot IEC		Loading Factors for Leakage Radiation	225 kV, 7.0 mA
Small	0.4 mm	X-Ray Tube Assembly Permanent Filtration	0.8 mm Be
Large	1.5 mm	High Voltage Cable	R24
Target Angle	20°	Weight (approx.)	10.5 kg (23.1 lbs)
Maximum Continuous Rating			
Small	640 W with 4 Litre/min cooling flow		
Large	1600 W with 4 Litre/min cooling flow		

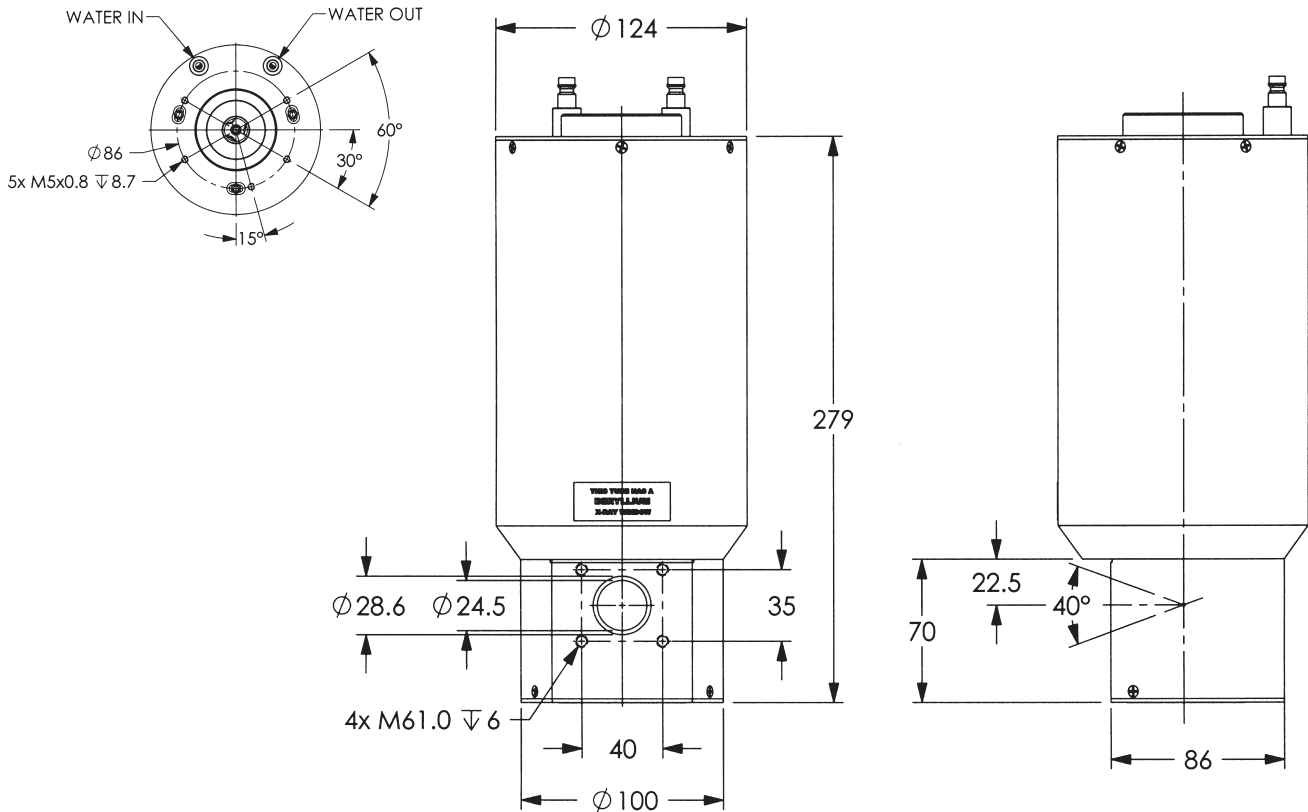

WARNING

Beryllium windows transmit a very high level of long wavelength X-radiation, which can injure human tissue. Injury may occur from even very short exposures to the primary X-ray beam. Follow all precautions necessary to avoid radiation exposure to humans.

The radiation dose rate cannot be accurately measured with conventional radiation measurement instruments. Radiation intensity in each installation will vary, and calibration must include the effects of long wavelength X-radiation.

Fumes from beryllium metal (or its compounds) as well as dust can be hazardous if inhaled. During use, corrosion products may occur on the beryllium window, but these should not be scraped off, machined, or otherwise removed. Tube unit disposal should conform to federal, state, and local regulations governing beryllium.

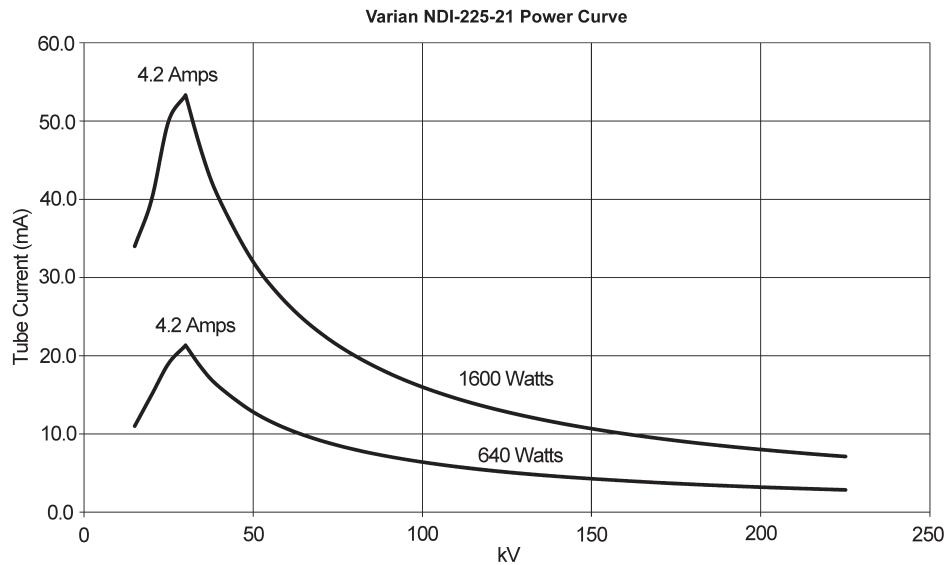

Instructions for Installation and Operation

Instructions for Installation

Connection of the x-ray tube

The careful adjustment of the pressure gap and the use of the correct amount of silicone grease are extremely important. First, clean the rubber cone carefully with a lint-free cloth. Take specific care that the contacts are absolutely free of old grease or oxide layers. Use only pure alcohol for cleaning, no other detergents. Cover the entire cone with a thin film of the supplied silicone grease, apply a rope of approximately 3 cm of grease and spread it gently, avoiding the contact tip. The grease layer must be kept free of air bubbles, dust or dirt.

Cable terminal with mounting flange

Rotate the mounting flange until there is a gap of 3-4 mm between the mounting flange and the tube. Remove the cable plug and carefully grease using the supplied high voltage insulating compound. Introduce the greased terminal plug parallel to the axis of the high voltage receptacle socket and advance until it stops.

Mounting flange

Attach the mounting flange to the tube housing using the flange fastening screws making sure not to rotate the mounting flange from its setup position.

Operation

General

The control of the high voltage and the filament current as well as the design of the cooling unit is the responsibility of the equipment manufacturer.

High Voltage Connection

One terminal type R24 high voltage cables supply high voltage and filament current.

Two different methods of mounting the high voltage cable are available.

Cooling of the Anode

It is the responsibility of the customer to ensure that the cooling medium flow meets the required cooling conditions. Insufficient cooling of the anode can lead to the destruction of the anode, therefore cooling must be switched on before the application of high voltage.

Control of Cooling Medium

Flow, pressure, and temperature of the cooling medium at the inlet to the tube or the tube assembly must be appropriately monitored. High voltage must be terminated when the pressure or flow rate fall below the minimum level or when the temperature exceeds the maximum level. When the tube is switched off the coolant flow must continue for at least 2 minutes in order to protect the anode from destruction.