



# AmpMC 3 field non-integrated Series

Intended Part numbers as listed in Table 1



**Technical Manual**

# Table of Contents

Table of Figures .....	3
1. Introduction .....	4
1.1. Contact information .....	4
1.2. Declaration of Conformance .....	4
1.3. Symbols used in this document .....	4
1.4. Abbreviations .....	5
1.5. General warnings, cautions and notes.....	5
1.6. Supplied components.....	5
1.7. Accessories .....	6
2. Product description .....	7
2.1. Intended use .....	7
2.2. Description of the device.....	7
2.3. Principle of operation .....	7
2.4. Classifications .....	7
2.5. Restrictions on use.....	7
2.6. Contraindications .....	8
2.7. Overview of the device.....	8
2.8. Specifications .....	8
3. Installation.....	9
3.1. Installation requirements .....	9
3.2. General Installation instructions .....	9
3.3. Generator Switch off check .....	9
3.4. Necessary recurrent testing .....	9
4. Mains isolation .....	10
5. Service, maintenance and cleaning .....	10
5.1. Quality Assurance .....	10
5.2. Safety precautions .....	10
5.3. Cleaning .....	10
5.4. Disinfection.....	10
5.5. Procedure at defects .....	10
6. Device Data .....	11
6.1. AmpMC 1002 Non-integrated amplifier.....	11
6.2. Generator Interface connections.....	11
6.3. Sensitivity settings.....	12
7. Quality Assurance (QA) .....	12
8. Disposal, ESD and EMC compatibility .....	13
8.1. Disposal.....	13
8.2. ESD .....	13
8.3. EMC compatibility .....	13
8.4. Deviations.....	14
8.5. Allowances .....	14
8.6. Precautions .....	14
8.7. Emissions Compliance.....	14
8.8. Immunity Compliance.....	14
9. Product label and symbols on the device .....	17
9.1. Product label .....	17
9.2. Symbols on the device .....	17

## Table of Figures

Figure 1 Means of protection .....	10
Figure 2 1002 looks .....	11
Figure 3 Lay-out Mechanical .....	11
Figure 4 Micro Ribbon 14 pin .....	11
Figure 5 DIL-switches AmpMC 1002 (Indicative only, See Table below for settings) .....	12
Figure 6 Extension cable for AmpMC 1002.....	12

### All rights reserved

Although this guide is prepared with utmost precaution, Varex Imaging Nederland B.V. assumes no responsibility for errors or omissions.

Varex Imaging Nederland B.V. shall not be liable against any damages of any nature arising from the use and use of any options other than original Varex Imaging Nederland B.V. products.

# 1. Introduction

## 1.1. Contact information

This manual provides all the technical information necessary for the correct installation, application and maintenance of the AmpMC.

If you need additional information, need support or want to report a problem with the device, please contact your distributor or Varex Imaging Nederland B.V.:

	Manufacturer	Distributor
Name	Varex Imaging Nederland B.V.	
Address	Fabriekstraat 41, 7005 AP Doetinchem The Netherlands	
Telephone	+31 (0)315 659150	
Fax	+31 (0)315 659140	
E-mail	<a href="mailto:Netherlands.CNC@vareximaging.com">Netherlands.CNC@vareximaging.com</a>	
Website	<a href="http://www.vareximaging.com">www.vareximaging.com</a>	

For support and service purposes, please note the following information:



Model name:	
Part number:	
Serial number:	

## 1.2. Declaration of Conformance

Varex Imaging Nederland B.V. hereby declares that this product is in conformity with the essential requirements and provisions as set forth in European Union Council Directive 93/42/EEC concerning medical devices (revision 2007-09-27). See the included Declaration document.

## 1.3. Symbols used in this document

To ensure adequate and clear understanding of the information provided in this manual, the symbols listed below are used to indicate warnings, cautions, actions and notes that are important for correct and safe use of the device.

	<p><b>WARNING:</b></p> <p>Warnings are directions which, if they are not followed, can cause fatal or serious injuries to a user, engineer, patient or any other person or can lead to a mistreatment.</p>
	<p><b>CAUTION:</b></p> <p>Cautions are directions which, if they are not followed, can cause damage to the device described in this manual or any other equipment or goods and can cause environmental pollution.</p>
	<p><b>NOTE:</b></p> <p>Notes provide advice and highlight unusual points. A note is not intended as an instruction.</p>



## 1.4. Abbreviations

Term	Definition
AEC	Automatic Exposure Control
EMC	Electromagnetic compatibility
ESD	Electro Static Discharge
ME	Medical Equipment

This document contains terminology and definitions based on (international) standards. The terminology and definitions are formatted in capital letters (e.g. INTENDED USE). Terminology and definitions from the following standards are used:

Reference	Title
IEC 60601-1	Medical electrical equipment – Part 1: General requirements for basic safety and essential performance
IEC 60601-1-2	Medical electrical equipment – Part 1-2: General requirements for basic safety and essential performance – Collateral Standard: Electromagnetic disturbances – Requirements and tests
IEC 60601-1-3	Medical electrical equipment – Part 1-3: General requirements for basic safety and essential performance – Collateral Standard: Radiation protection in diagnostic X-ray equipment
IEC 60601-2-54	Medical electrical equipment – Part 2-54: Particular requirements for the basic safety and essential performance of X-ray equipment for radiography and radioscopy

## 1.5. General warnings, cautions and notes

	<b>WARNING:</b> To avoid the risk of electric shock, this equipment must only be connected to a system insulated from supply mains according to IEC-60601-1
	<b>WARNING:</b> Do not modify this equipment without authorization of the manufacturer.
	<b>WARNING:</b> The device contains sensitive electronics. Ensure that ESD protective measures are in place when the device is installed or serviced to prevent damage to the device.

## 1.6. Supplied components

The device that you have purchased is packed in a package appropriately designed to ensure the integrity of the device. Please ensure that the contents of the package you received is intact and that there are no traces of moisture or visual damages. Otherwise, you should immediately contact your distributor or Varex Imaging Nederland B.V..

The package contains the following components:

Amount	Description	Reference
1	AmpMC	For Model and Part number see the product label on the AmpMC
1*	Documentation	Technical Manual TM20520-10 and Declaration of Conformity (CE)
1*	IFU card	Instruction for electronic download of documentation via Varex website

\*) One of these items must be supplied in the package

## 1.7. Accessories

The following accessories can be ordered separately.

Description	Purpose
<b>Extension cables, for use between SolidStateMC and AmpMC</b>	
EXTENSION CABLE, SSMC, 2.5M	To connect all 3 field SolidStateMC models to 3 field AmpMC.
EXTENSION CABLE, SSMC, 5M	
EXTENSION CABLE, SSMC, 10M	
EXTENSION CABLE, SSMC, 45FT	
EXTENSION CABLE, SSMC, 15M	
EXTENSION CABLE, SSMC, 18M	
EXTENSION CABLE, SSMC, 20M	
EXTENSION CABLE, SSMC, 25M	
<b>Extension cables, for use between the AmpMC and HV generator</b>	
EXTENSION CABLE, PREAMP-GEN, 25M	Centronics 14-pin Male – Hirose 7-pin Female)
<b>Various</b>	
Female connector 6 pin	Connector without cable, solder version. To connect to SolidStateMC
Male connector 6 pin	Connector without cable, solder version. To connect to AmpMC

## 2. Product description

### 2.1. Intended use

The device is intended to be used in medical diagnostic applications with restrictions to human diagnostics. The device is intended to be used as accessory of an X-ray system in a professional healthcare facility environment. The device is intended to amplify the output signal of a SolidStateMC to the AEC-module of an X-ray generator. The limitations of use are specified in §2.8. The device is not intended to be used in fluoroscopy applications; near active HF Surgical Equipment or in the RF shielded room of a system for magnetic resonance imaging, where the intensity of Electromagnetic Disturbances is high.

Use, other than above, is identified as abnormal use.

The device is intended as an internal component of an X-ray system. The intended user is defined as the SERVICE PERSONNEL of an X-ray system

### 2.2. Description of the device

The purpose of the automatic exposure control (AEC) of an X-ray system is to obtain the correct image contrast by measuring the radiation quantity striking the film or detector.

To result in a high-quality image, the AEC's exposure end switch will stop generating X-rays automatically when the demanded radiation dose on the detector is reached.

### 2.3. Principle of operation

Main functions of the AmpMC are:

- The conversion of electrical current from a SolidStateMC to a voltage level signal. The voltage level signal is proportional to the dose rate received by the SolidStateMC. The AmpMC converts the small current to a voltage signal that is proportional to the X-ray dose rate.

A SolidStateMC serves as a measuring device for X-ray radiation with semiconductor components (photodiodes) as actual sensors. The ionizing effect of X-ray produces a small electrical current in the SolidStateMC's photodiodes and this current is lead to the AmpMC.

- There is no signal available for external use about the status of the device.

### 2.4. Classifications

Subject	Classification	Reference
CE	IIB	93/42/EEC
Electrical safety	None	IEC 60601-1
Electromagnetic Compatibility intended environment	Professional healthcare facility environment	IEC 60601-1-2
Mode of operation	Continuous	IEC 60601-1
Ingress protection	IPX0	IEC 60529
Protection	None	IEC 60601-1
Not intended for use in Oxygen Rich environment.		
Not suitable for Sterilization.		

### 2.5. Restrictions on use

The AmpMC can only be used in combination with a SolidStateMC and in a Radiography X-ray system that complies with the IEC60601-1 standard applicable at date of manufacture.

The supply lines must be limited / fused to 15W max. or the AmpMC must be mounted inside a fire enclosure.

The AmpMC is intended to be installed inside a cabinet of the X-ray system.

Depending on final Assembly, additional measures may need to be taken to comply with EMC regulations.

## 2.6. Contraindications

The relevant contraindications for the X-ray system continue to apply (see the documentation for the X-ray system). The AmpMC does not add new contraindications on top of these.

## 2.7. Overview of the device

Table 1 AmpMC specifications

Model	Dimensions (mm)			Support information					Remarks
	Outside			Connections				Lay-out	
				SolidStateMC		Generator			
	W	L	H	Cable (m)	Connector	Cable (m)	Connector		
1002	68	194	35.5			None	Centronics 14p	§ 6.1	3 independent channels with voltage level outputs no field selection.
									Configuration of connections
									Connector type at generator side
									Cable length at generator side
									Connector type at SolidStateMC side
									Cable length at SolidStateMC side
									Height of AmpMC
									Length of AmpMC
									Width of AmpMC

## 2.8. Specifications

Description	Reference
Exposure time range	≤ 4 ms to 5 s.
Input range <sup>*)</sup>	0 to 3800 nA @ +/-12 VDC supply 0 to 4600 nA @ +/-15 VDC supply
Operating voltage	+/- 12 VDC +/-5% to +/- 15 VDC +/-5% Measured at the AmpMC.
Supply current	0.1 A @ + 12 VDC; 0.1 A @ - 12 VDC 0.1 A @ + 15 VDC; 0.1 A @ - 15 VDC
Output signal	0 to -10 V @ +/-12 VDC supply 0 to -12 V @ +/-15 VDC supply
Applicable standards	IEC60601-1 IEC60601-1-2 IEC60601-1-3 IEC60601-2-54
Housing Material	Sheet metal
Weight	< 0.5 kg
Operation environment	Ambient temperature: +10°C to +40°C Relative humidity: 35% to 85% non-condensing Atm. Pressure: 860hPa to 1060hPa
Storage	Ambient temperature: -20°C to +60°C Relative humidity: 35% to 85% non-condensing Atm. Pressure: 860hPa to 1060hPa

<sup>\*)</sup> depending on gain settings





### 3. Installation

	<p><b>NOTE:</b> Allow system to level with room temperature before installation.</p>
---	--

#### 3.1. Installation requirements

	<p><b>WARNING:</b> Installation and initial operation may only be carried out by an expert who has been trained in the field of medical diagnostic X-ray equipment.</p>
---	---

	<p><b>WARNING:</b> Modifications to the product are not allowed.</p>
---	--

	<p><b>WARNING:</b> When the enclosure is opened, ESD protective measures must be taken to prevent damage to the electronics.</p>
---	--

	<p><b>WARNING:</b> Always use shielded cable, the total length of this cable shall not exceed 30 meters.</p>
---	--

	<p><b>WARNING:</b> Improper grounding can cause incorrect functioning of the AmpMC</p>
---	--

	<p><b>WARNING:</b> Adjust the potentiometers with great caution. Using excessive force or over adjustment will result in improper functioning of the AmpMC</p>
---	--

#### 3.2. General Installation instructions

Position the AmpMC always outside of the active image area. The position of the AmpMC is not critical and can be mounted anywhere on the system. If the cable lengths are inadequate see the accessories list in §1.7.

Connect the AmpMC to the control electronics in the generator by means of the connector, see chapter 6. The connection diagram and plug pin lay-out of this cable are found under chapter 6.

Correct functioning of the AmpMC is guaranteed only if the cable as well as the SolidStateMC shielding is properly connected.

After the function control, the automatic exposure control is set to the correct dose, checked in all kV-ranges and for all film-foil-combinations (if applicable) and put into operation. This procedure must be done according to the manual of the x-ray system.

#### 3.3. Generator Switch off check

Without a patient or phantom, a radiation exposure with 80kV, 100mA, 21 s is released. The automatic exposure control must terminate the exposure in less than 100 ms.

#### 3.4. Necessary recurrent testing

	<p><b>WARNING:</b> Before granting the automatic exposure control for use on patients, check the functionality of all AEC fields with a phantom.</p>
---	--

## 4. Mains isolation

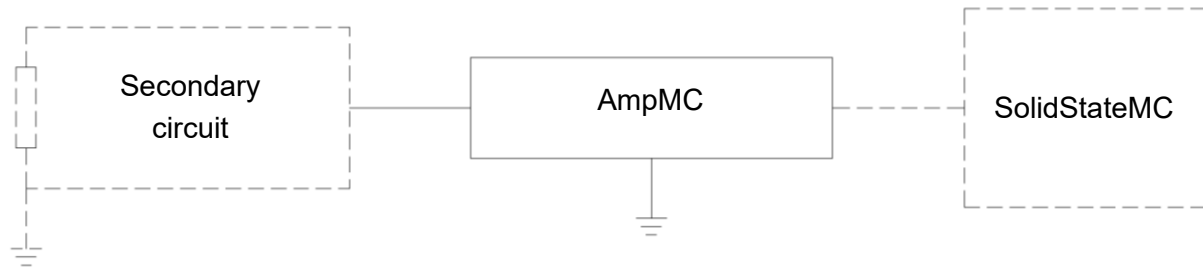

Figure 1 Means of protection

The AmpMC always needs to be connected to an X-ray system that complies with the required regulations and standards.

## 5. Service, maintenance and cleaning

Refer service to a qualified service technician only.

AmpMC models do not require any maintenance and will last during the lifetime of the X-ray system. For calibration see chapter 7.

In case of malfunction of the AEC system, the AmpMC can be checked according to the described test procedure §5.5.

### 5.1. Quality Assurance

In case of malfunction of the AEC system, the AmpMC can be checked according to the described test procedure §5.5.

### 5.2. Safety precautions

When there is structural damage to the housing or cable of the device, label the device as “out of order” and have the device repaired prior to further use.

### 5.3. Cleaning

Cleaning with a damp cloth is recommended. Use generally available alcohol-based cleaning agents and do not soak the device with liquid.

### 5.4. Disinfection

Disinfection, when required, with a damp cloth with Isopropyl alcohol is recommended. Before using a disinfectant, check at a spot on the bottom of the device if the disinfectant will not damage the plastic and coated metal surfaces.

Do not soak the device with liquid.

### 5.5. Procedure at defects

- Exchange the extension cable (if present).
- Exchange AmpMC

## 6. Device Data

### 6.1. AmpMC 1002 Non-integrated amplifier

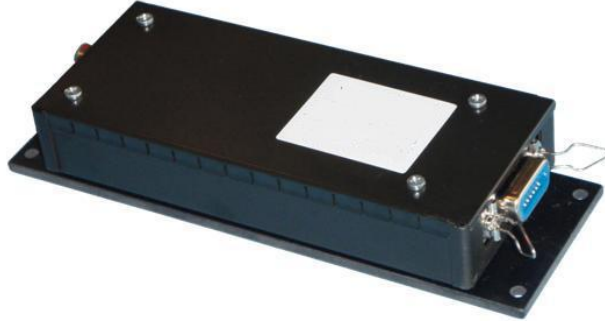

Figure 2 1002 looks

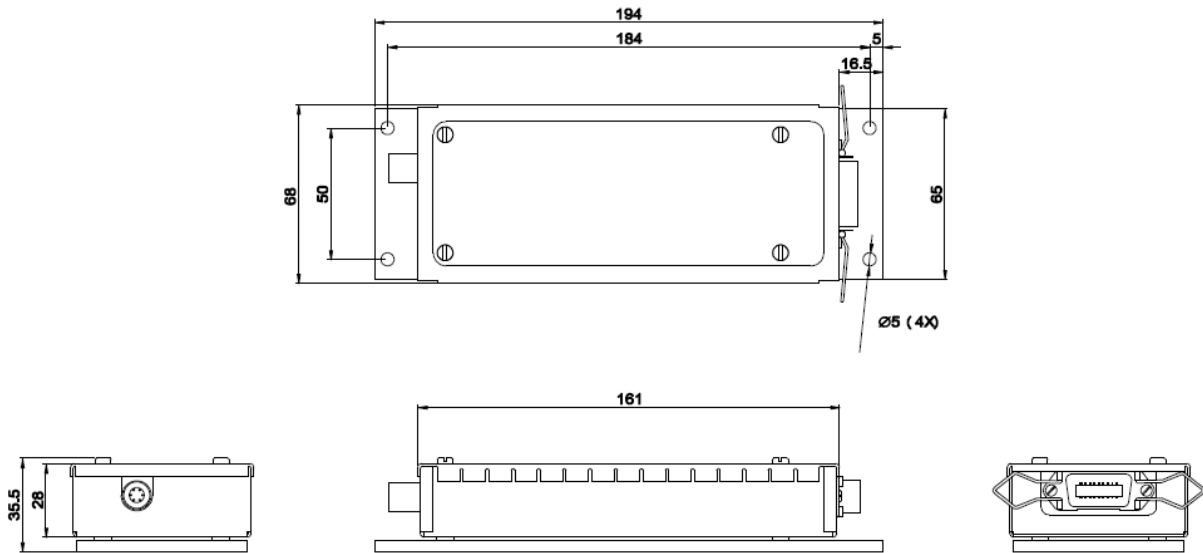

Figure 3 Lay-out Mechanical

### 6.2. Generator Interface connections

Pin	Designation
2	- 12 VDC to - 15 VDC
4	GND
6	+ 12 VDC to + 15 VDC
8	Shield
10	Field III output
12	Field II output
14	Field I output
1-3-5-7-9-11-13	Not connected

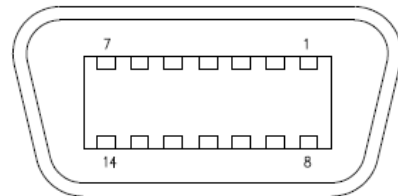

Figure 4 Micro Ribbon 14 pin

### 6.3. Sensitivity settings

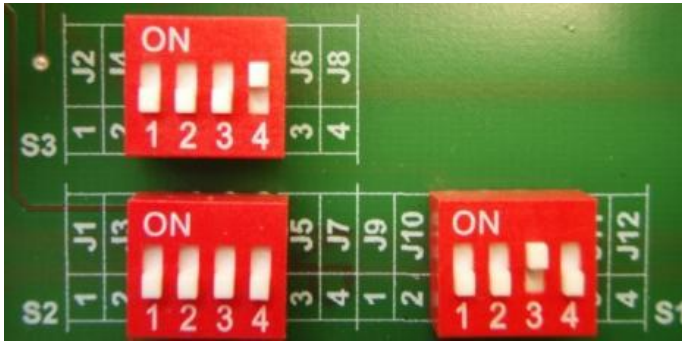

Figure 5 DIL-switches AmpMC 1002 (Indicative only, See Table below for settings)

Gain level	S1.1	S1.2	S1.3	S1.4	S2.1	S2.2	S2.3	S2.4	S3.1	S3.2	S3.3	S3.4	Setting code
1 (min)	OFF	OFF	ON	OFF	ON	OFF	OFF	OFF	OFF	OFF	OFF	ON	0
2 (Standard version)	ON	OFF	OFF	OFF	OFF	OFF	OFF	ON	OFF	ON	OFF	OFF	1
3 (moderate)	OFF	ON	OFF	OFF	OFF	ON	OFF	OFF	ON	OFF	OFF	OFF	2
4 (max)	OFF	OFF	OFF	ON	OFF	OFF	ON	OFF	OFF	OFF	ON	OFF	3

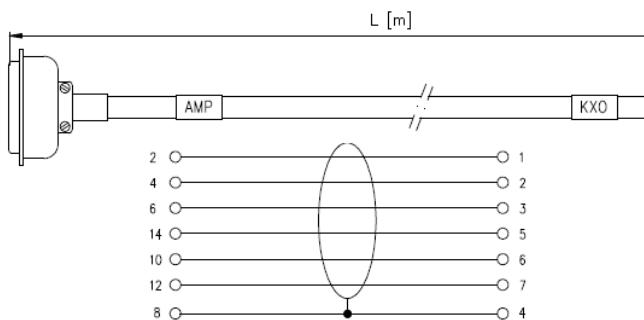

Figure 6 Extension cable for AmpMC 1002

## 7. Quality Assurance (QA)

An AmpMC makes part of the X-ray systems performance requirements and the adjustment procedures for the complete X-ray system are mandatory. There are no additional QA procedures for using the AmpMC.

## 8. Disposal, ESD and EMC compatibility

### 8.1. Disposal

This device contains substances that can be hazardous to the environment and care should be taken when disposed of.

The device is marked with the following symbol:







Follow local regulations regarding disposal of devices that contain electronic parts.

### 8.2. ESD

	<p><b>WARNING:</b> The device contains sensitive electronics. Ensure that ESD protective measures are in place when the device is installed or serviced to prevent damage to the device.</p>
---	--

### 8.3. EMC compatibility

The device conforms to IEC60601-1-2:2014 for EMC compatibility and must be installed and put into service according to the EMC information provided in this manual.

	<p><b>WARNING:</b> Portable RF communications equipment (including peripherals such as antenna cables and external antennas) should be used no closer than 30 cm (12 inches) to any part of the [ME EQUIPMENT or ME SYSTEM], including cables specified by the manufacturer. Otherwise, degradation of the performance of this equipment could result.</p>
	<p><b>WARNING:</b> Not taking EMC measures into account on the wiring may result in increased EMISSIONS or decreased IMMUNITY. IEC60601-1-2:2014 must be followed for being complaint with EMC guidelines.</p>
	<p><b>WARNING:</b> Use of this equipment adjacent to or stacked with other equipment should be avoided because it could result in improper operation. If such use is necessary, this equipment and the other equipment should be observed to verify that they are operating normally.</p>
	<p><b>WARNING:</b> Use of accessories, transducers and cables other than those specified or provided by the manufacturer of this equipment could result in increased Electromagnetic emissions or decreased Electromagnetic immunity of this equipment and result in improper operation.</p>
	<p><b>NOTE:</b> The EMISSIONS characteristics of this equipment make it suitable for use in industrial areas and hospitals (CISPR 11 class A). If it is used in a residential environment (for which CISPR 11 class B is normally required) this equipment might not offer adequate protection to radio-frequency communication services. The user might need to take mitigation measures, such as relocating or re-orienting the equipment.</p>

## 8.4. Deviations

No deviations from IEC60601-1-2:2014 are applied.

## 8.5. Allowances

No allowances from IEC60601-1-2:2014 are used.

## 8.6. Precautions

Precautions to be taken to prevent adverse events to the PATIENT and the OPERATOR due to Electromagnetic Disturbances are listed in the column “Electromagnetic environment – guidance” in the tables below.

## 8.7. Emissions Compliance

Guidance and manufacturer’s declaration – Electromagnetic emissions		
The AmpMC 3 field non-integrated are intended for use in the Electromagnetic environment specified below. The customer or user of the AmpMC 3 field non-integrated should assure that it is used in such an environment.		
Emissions test	Compliance	Electromagnetic environment - guidance
RF emissions group CISPR 11	Group 1	The AmpMC 3 field non-integrated uses RF energy only for its internal function. Therefore, its RF emissions are very low and are not likely to cause any interference in nearby electronic equipment.
RF emissions class CISPR 11	Class A	The EMISSIONS characteristics of AmpMC 3 field make it suitable for use in industrial areas and hospitals (CISPR 11 class A). If it is used in a residential environment (for which CISPR 11 class B is normally required) this equipment might not offer adequate protection to radio-frequency communication services. The user might need to take mitigation measures, such as relocating or re-orienting the equipment.”
Harmonic emissions IEC 61000-3-2	Not Applicable	
Voltage fluctuations/ flicker emissions IEC 61000-3-3	Not Applicable	

## 8.8. Immunity Compliance

Guidance and manufacturer’s declaration – Electromagnetic immunity – ENCLOSURE PORT		
The AmpMC 3 field non-integrated are intended for use in the Electromagnetic environment specified below. The customer or user of the AmpMC 3 field non-integrated should assure that it is used in such an environment.		
Immunity test	Compliance Test level	Electromagnetic environment – guidance
Electrostatic discharge (ESD) IEC 61000-4-2	± 8 kV contact ± 2 kV, ± 4 kV, ± 8 kV, ± 15 kV air	Floors should be wood, concrete or ceramic tile. If floors are covered with synthetic material, the relative humidity should be at least 30 %.
Proximity fields from RF wireless communications equipment IEC 61000-4-3	See next table below	Portable RF communications equipment (including peripherals such as antenna cables and external antennas) should be used no closer than 30 cm (12 inches)
Power frequency (50/60 Hz) magnetic field IEC 61000-4-8	Not applicable	Power frequency magnetic fields should be at levels characteristic of a typical location in a typical commercial or hospital environment.

Guidance and manufacturer's declaration – Electromagnetic immunity – Compliance Test Levels for ENCLOSURE PORT IMMUNITY to RF wireless communications equipment						
Test frequency (MHz)	Band (MHz)	Service <sup>a)</sup>	Modulation	Maximum power (W)	Distance (m)	IMMUNITY TEST LEVEL (V/m)
385	380 – 390	TETRA 400	Pulse modulation <sup>b)</sup> 18 Hz	1,8	0,3	27
450	430 – 470	GMRS 460; FRS 460	FM ± 5 kHz deviation 1 kHz sine	2	0,3	28
710	704 – 787	LTE Band 13, 17	Pulse Modulation <sup>b)</sup>	0,2	0,3	9
745						
780			217 Hz			
810	800 – 960	GMS 800/900; TETRA 800; iDEN 820; CDMA 850; LTE Band 5	Pulse Modulation <sup>b)</sup>	2	0,3	28
870						
930			18 Hz			
1 720	1 700 – 1 990	GSM 1800; CDMA 1900; GSM 1900; DECT; LTE Band 1, 3, 4, 25; UMTS	Pulse Modulation <sup>b)</sup>	2	0,3	28
1 845						
1 970			217 Hz			
2 450	2 400 – 2 570	Bluetooth; WLAN 802.11 b/g/n; RFID 2450; LTE Band 7	Pulse Modulation <sup>b)</sup> 217 Hz	2	0,3	28
5 240	5 100 – 5 800	WLAN 802.11 a/n	Pulse Modulation <sup>b)</sup>	0,2	0,3	9
5 500						
5 785			217 Hz			

<sup>a)</sup> For some services, only the uplink frequencies are included.  
<sup>b)</sup> The carrier is modulated using a 50 % duty cycle square wave signal.

Guidance and manufacturer's declaration – Electromagnetic immunity – Power and Signal PORTs		
The AmpMC 3 field non-integrated are intended for use in the Electromagnetic environment specified below. The customer or user of the AmpMC 3 field non-integrated should assure that it is used in such an environment.		
Immunity test	Compliance Test level	Electromagnetic environment - guidance
Electrostatic discharge (ESD) IEC 61000-4-2	± 8 kV contact ± 2 kV, ± 4 kV, ± 8 kV, ± 15 kV air	Floors should be wood, concrete or ceramic tile. If floors are covered with synthetic material, the relative humidity should be at least 30 %.
Electrical fast transient/burst IEC 61000-4-4	± 2 kV AC and DC power ports ± 1 kV signal ports 100kHz repetition frequency	Mains power quality should be that of a typical commercial or hospital environment.
Surges Line-to-line IEC 61000-4-5	Not Applicable	The AmpMC 3 field non-integrated is intended to be supplied by a secondary IEC60601-1 compliant AC or DC power supply.
Surges Line-to-ground IEC 61000-4-5	Not Applicable	
Conducted disturbances induced by RF fields IEC 61000-4-6	3 V <sup>a)</sup> 0,15 MHz – 80 Mhz  6 V <sup>a)</sup> in ISM bands between 0,15 MHz and 80 MHz <sup>b)</sup>  80 % AM at 1 kHz	Field strengths from fixed RF transmitters, as determined by an Electromagnetic site survey <sup>c)</sup> , should be less than the compliance level in each frequency range.  Interference may occur near equipment marked with the following symbol:  
Voltage dips IEC 61000-4-11	Not Applicable	The AmpMC 3 field non-integrating series is intended to be supplied by a secondary IEC60601-1 compliant AC or DC power supply.
Voltage interruptions IEC 61000-4-11	Not Applicable	
<p><sup>a)</sup> r.m.s. before modulation is applied</p> <p><sup>b)</sup> The ISM (industrial, scientific and medical) bands between 150 kHz and 80 MHz are 6,765 MHz to 6,795 MHz; 13,553 MHz to 13,567 MHz; 26,957 MHz to 27,283 MHz; and 40,66 MHz to 40,70 MHz. The amateur radio bands between 0,15 MHz and 80 MHz are 1,8 MHz to 2,0 MHz, 3,5 MHz to 4,0 MHz, 5,3 MHz to 5,4 MHz, 7 MHz to 7,3 MHz, 10,1 MHz to 10,15 MHz, 14 MHz to 14,2 MHz, 18,07 MHz to 18,17 MHz, 21,0 MHz to 21,4 MHz, 24,89 MHz to 24,99 MHz, 28,0 MHz to 29,7 MHz and 50,0 MHz to 54,0 MHz.</p> <p><sup>c)</sup> Field strengths from fixed transmitters, such as base stations for radio (cellular/cordless) telephones and land mobile radios, amateur radio, AM and FM radio broadcast and TV broadcast cannot be predicted theoretically with accuracy. To assess the Electromagnetic environment due to fixed RF transmitters, an Electromagnetic site survey should be considered. If the measured field strength in the location in which the AmpMC 3 field non-integrated is used exceeds the applicable RF compliance level above, the AmpMC 3 field non-integrated should be observed to verify normal operation. If abnormal performance is observed, additional measures may be necessary, such as re-orienting or relocating the AmpMC 3 field non-integrated.</p> <p><b>NOTE</b> These guidelines may not apply in all situations. Electromagnetic propagation is affected by absorption and reflection from structures, objects and people</p>		









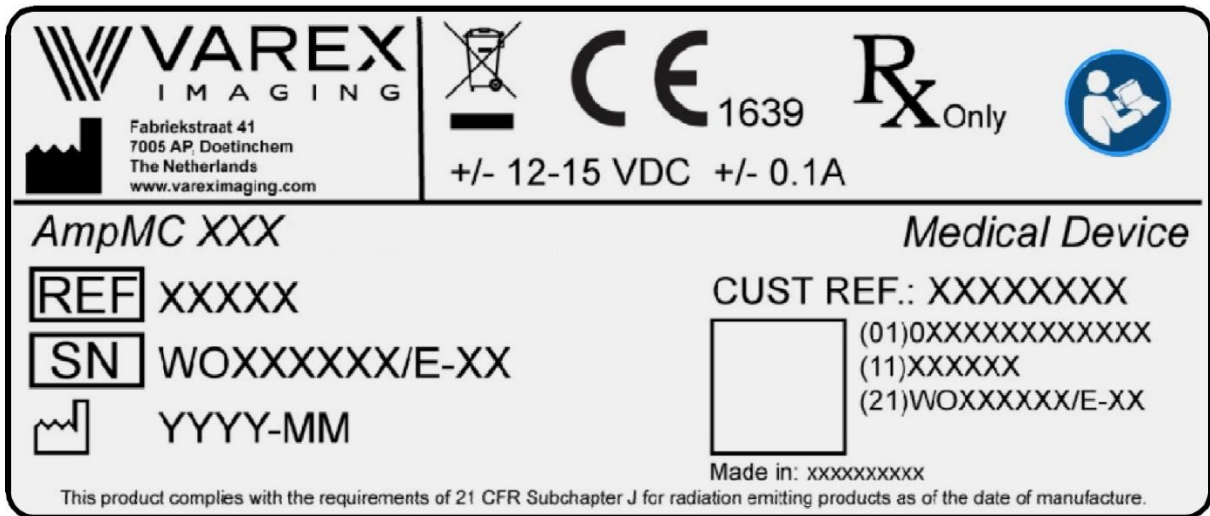

## 9. Product label and symbols on the device

### 9.1. Product label

The product label can be found at the top side of the AmpMC.



### 9.2. Symbols on the device

Symbol	Explanation
	Manufacturer.
	Date of manufacture.
	Catalogue number.
	Serial number.
	CE-mark directive 93/42/EC; conformity assessment by notified body 1639.
	Follow the instructions for use. Reading the instructions for use is crucial for a correct and safe use of the AmpMC.
	Identification of compliance with the provisions for EU WEEE directive.
	For professional use only.
	Identification of compliance with FCC 47 CFR Part 15 (optional feature).

This page is left blank intentionally.

## Contact details

### Varex Imaging Nederland B.V.

The Netherlands

t +31 315 659 150

f +31 315 659 140

[Netherlands.CNC@vareximaging.com](mailto:Netherlands.CNC@vareximaging.com)

### Varex Imaging Americas Corp.

U.S.A.

t +1 847 279 5100

f +1 630 271 9995

[Americas.CNC@vareximaging.com](mailto:Americas.CNC@vareximaging.com)

### Varex Imaging Technology (Beijing) Co., Ltd.

China

t +86 10 6780 2708

t +86 10 6780 2129

f +86 10 6780 2170

[China.CNC@vareximaging.com](mailto:China.CNC@vareximaging.com)

### Varex Imaging Philippines Inc.

Philippines

t +63 49 5024 520

t +63 49 5024 521

f +63 49 5024 500

f +63 2 8076 472

[Philippines.CNC@vareximaging.com](mailto:Philippines.CNC@vareximaging.com)

© 2020 by Varex Imaging Nederland B.V.

All Rights reserved. No part of this document may be reproduced or transmitted in any form or by any means, electronic, mechanical, photocopying, recording, or otherwise, without prior written permission of Varex Imaging Nederland B.V.

