

Figure only indicative

SolidStateMC 3 field Series

Intended for Part numbers as listed in Table 1

CE₀₁₂₀

Technical Manual

Table of Contents

1.	Introduction	4
1.1.	Contact information	4
1.2.	Declaration of Conformance	4
1.3.	Symbols used in this document	4
1.4.	Abbreviations	5
1.5.	General warnings, cautions and notes.....	5
1.6.	Supplied components.....	5
1.7.	Accessories	6
2.	Product description	7
2.1.	Intended use	7
2.2.	Description of the device.....	7
2.3.	Principle of operation	7
2.4.	Classifications Subject	7
2.5.	Restrictions on use.....	7
2.6.	Contraindications	7
2.7.	Overview of the device.....	8
2.8.	Specifications	9
3.	Installation.....	10
3.1.	Installation requirements	10
3.2.	Installation instructions	10
3.3.	Necessary recurrent testing	10
4.	Mains isolation	11
5.	Service, maintenance and cleaning	12
5.1.	Safety precautions	12
5.1.1.	Procedure at defects	12
5.2.	Device Data.....	12
5.2.1.	Connections.....	12
5.2.2.	Equivalent schematic.....	12
5.2.3.	Lay-out of SolidStateMC.....	13
5.3.	Cleaning	13
5.4.	Disinfection.....	13
5.5.	Test Procedure	14
5.5.1.	Check-up on open contacts or short circuits	14
5.5.2.	Auxiliary measurement under radiation.....	14
6.	Quality Assurance (QA)	14
7.	Disposal, ESD and EMC compatibility	15
7.1.	Disposal	15
7.2.	ESD	15
7.3.	EMC compatibility	15
7.3.1.	Deviations	15
7.3.2.	Allowances	15
7.3.3.	Precautions.....	16
7.3.4.	Emissions Compliance	16
7.3.5.	Immunity Compliance	16
8.	Product label and symbols on the device.....	19
8.1.	Product label	19
8.2.	Symbols on the device	19

Table of Figures

Figure 1 Means of protection.....	11
Figure 2 Connector lay-out solder side view	12
Figure 3 Equivalent Schematic.....	12
Figure 4 Mechanical Lay-out	13

All rights reserved

Although this guide is prepared with utmost care, Varex Imaging Nederland B.V. assumes no responsibility for errors or omissions.

Varex Imaging Nederland B.V. cannot be held accountable from damages of any nature arising from the use and use of any options other than original Varex Imaging Nederland B.V. products.

1. Introduction

1.1. Contact information

This manual provides all the technical information necessary for the correct installation, application and maintenance of the SolidStateMC.

If you need additional information, need support or want to report a problem with the device, please contact your distributor or Varex Imaging Nederland B.V.:

	Manufacturer	Distributor
Name	Varex Imaging Nederland B.V.	
Address	Anholtseweg 44 7091 HB Dinxperlo The Netherlands	
Telephone	+31 (0)315 659150	
Fax	+31 (0)315 659140	
E-mail	Netherlands.CNC@vareximaging.com	
Website	www.vareximaging.com	

For support and service purposes, please copy the following information from the product label:



Model name:	
Part number:	
Serial number:	

1.2. Declaration of Conformance

Varex Imaging Nederland B.V. hereby declares that this product is in conformity with the essential requirements and provisions as set forth in European Union Council Directive 93/42/EEC concerning medical devices (revision 2007-09-27). See the included Declaration document.

1.3. Symbols used in this document

To ensure adequate and clear understanding of the information provided in this manual, the symbols listed below are used to indicate warnings, cautions, actions and notes that are important for correct and safe use of the device.

	<p>WARNING:</p> <p>Warnings are directions which, if they are not followed, can cause fatal or serious injuries to a user, engineer, patient or any other person or can lead to a mistreatment.</p>
	<p>CAUTION:</p> <p>Cautions are directions which, if they are not followed, can cause damage to the device described in this manual or any other equipment or goods and can cause environmental pollution.</p>
	<p>NOTE:</p> <p>Notes provide advice and highlight unusual points. A note is not intended as an instruction.</p>





1.4. Abbreviations

Term	Definition
EMC	Electromagnetic compatibility
ESD	Electro Static Discharge
ME	Medical Equipment
N.A.	Not Applicable

This document contains terminology and definitions based on (international) standards. The terminology and definitions are formatted in capital letters (e.g. INTENDED USE). Terminology and definitions from the following standards are used:

Reference	Title
IEC 60601-1	Medical electrical equipment – Part 1: General requirements for basic safety and essential performance
IEC 60601-1-2	Medical electrical equipment – Part 1-2: General requirements for basic safety and essential performance – Collateral Standard: Electromagnetic disturbances – Requirements and tests
IEC 60601-1-3	Medical electrical equipment – Part 1-3: General requirements for basic safety and essential performance – Collateral Standard: Radiation protection in diagnostic X-ray equipment
IEC 60601-2-54	Medical electrical equipment – Part 2-54: Particular requirements for the basic safety and essential performance of X-ray equipment for radiography and radioscopy

1.5. General warnings, cautions and notes

	WARNING: To avoid the risk of electric shock, this equipment must only be connected to a system insulated from supply mains according to IEC-60601-1
	WARNING: The SolidStateMC is a delicate device and needs to be handled with care.
	WARNING: Do not modify this equipment without authorization of the manufacturer. This includes drilling holes.
	WARNING: The device contains sensitive electronics. Ensure that ESD protective measures are in place when the device is installed or serviced to prevent damage to the device.

1.6. Supplied components

The device is packed in a package appropriately designed to ensure the integrity of the device. Please ensure that the contents of the package you received is intact and that there are no traces of moisture or visual damages. Otherwise, you should immediately contact your distributor or Varex Imaging Nederland B.V..

The package contains the following components:

Amount	Description	Reference
1	SolidStateMC	For Model and Part number see the product label on the SolidStateMC
1	Technical Manual	TM20416-10
1	ECDoc	Declaration of Conformity

1.7. Accessories

The following accessories can be ordered separately.

Description		Purpose	
EXTENSION CABLE, SSMC, 2.5M		Extension cable, for use between SolidStateMC and AmpMC	
EXTENSION CABLE, SSMC, 5M			
EXTENSION CABLE, SSMC, 10M			
EXTENSION CABLE, SSMC, 45FT			
EXTENSION CABLE, SSMC, 15M			
EXTENSION CABLE, SSMC, 18M			
EXTENSION CABLE, SSMC, 20M			
EXTENSION CABLE, SSMC, 20M, OE			
EXTENSION CABLE, SSMC, 25M			
Various			
Female connector 6 pin		Connector without cable, solder version	
Male connector 6 pin		Connector without cable, solder version	
AmpMC models¹ for 3 field SolidStateMC models, voltage ramp output			
Model	# of outputs	Field sel.	Connector at generator side
AmpMC 1001	1	Yes	Sub-D 9-pin Male
AmpMC 1008	1	Yes	Header 10-pin female
AmpMC models for 3 field SolidStateMC models, voltage ramp output which is shorted during reset period			
AmpMC 1006	1	Yes	Sub-D 9pin Male
AmpMC models for 3 field SolidStateMC models, 3 fully independent channels, voltage level outputs			
AmpMC 1002	3	No	Centronics 14pin

¹ For further specifications see the relevant AmpMC manual.

2. Product description

2.1. Intended use

The SolidStateMC is intended to be used in medical diagnostic applications with restrictions to human diagnostics. The device is intended to be used as accessory of an X-ray system in a professional healthcare facility environment. The device is intended to measure the intensity of the X-ray beam before entering the imaging receptor (e.g. film, detector). The restrictions on use are specified in §2.5. The device is not intended to be used in fluoroscopy applications; near active HF Surgical Equipment or in the RF shielded room of a system for magnetic resonance imaging, where the intensity of Electromagnetic Disturbances is high.

Use, other than above, is identified as abnormal use.

The device is intended as an internal component of an X-ray system. The intended user is defined as SERVICE PERSONNEL of an X-ray system.

2.2. Description of the device

The SolidStateMC is intended to be used for measuring X-ray radiation in a Radiography X-ray system. The SolidStateMC must be placed between a patient and an imaging receptor (e.g. film, detector) to generate a signal that is used by an automatic exposure control unit to establish optimized exposure parameters to a patient.

2.3. Principle of operation

The SolidStateMC as described in this document, is to generate a real time electrical signal equivalent to the X-ray dose rate for medical radiology. This signal is generated by X-ray sensitive photodiodes.

2.4. Classifications

Subject	Classification	Reference
CE	IIB	93/42/EEC
Electrical safety	None	IEC 60601-1
Electromagnetic Compatibility intended environment	Professional healthcare facility environment	IEC 60601-1-2
Mode of operation	Continuous	IEC 60601-1
Ingress protection	IP2X	IEC 60529
Protection	1 MOPP @ 43VDC	IEC 60601-1
Not intended for use in Oxygen Rich environment.		
Not suitable for Sterilization.		

2.5. Restrictions on use

The SolidStateMC can only be used in combination with an amplifier in a Radiography X-ray system that complies with the IEC60601-1 standard applicable at date of manufacture.

The SolidStateMC is intended to be installed inside a cassette holder (Bucky system) of the X-ray system. Depending on final assembly, additional EMC measures may need to be taken.

The relevant restrictions for the X-ray system continue to apply (see the documentation of the X-ray system). The SolidStateMC does not add new restrictions on top of these.

2.6. Contraindications

The relevant contraindications for the X-ray system continue to apply (see the documentation for the X-ray system). The SolidStateMC does not add new contraindications on top of these.

2.7. Overview of the device

Table 1 SolidStateMC specifications

Model	Cover material	Dimensions (mm)															Cable length	Cable exit	Sensitivity X10 ⁻³ A/μGy/s	Remarks	
		Outside				Holes			Image area		Field										
		W	L	T	Tc	D	Wh	Lh	Wi	Li	I		II/III		II-III						
601	P	472	460	3	6.5	-	-	-	430	430	50	100	55	90	145	70	650	Right bottom	1.5		
501	C					-	-	-											2.4		
613	P					-	-	-									900	Right top	1.5		
616						Ø4	300	449									750	Left bottom			
614	P	475	464	3.3	7.6	-	-	-									650	Right bottom	1.5	Reinforce ments all sides	
625		460	460			-	-	-									950	Right bottom			
619				6		-	-	-										Left bottom			
609		465		3.3	7	-	-	-										Right bottom			
621		465	465	6	7.6	-	-	-							131		1500	Left bottom			
510	C	450	450	2.7		-	-	-			51	112	55			158	70	950	Right bottom		
617	P			3.3		-	-	-													
502	C	472	460	3	6.5	-	-	-								145	70	650		1.2	
507	C	470	476	3		-	-	-	445		50	100	55					250	Left top	2.4	
605	P	387	460	3		-	-	-	360	430								650	Left top	1.5	
610	P	470	450	6	7.6	-	-	-	430	450	51	112				158		1500	Right bottom		
506	C	390	380	3	6.5	-	-	-	360	350	37	90	37			147		1040		1.2	
																					Field I, II and III sensitivities
																					Exit point of cable
																					Cable length including connector
																					Offset from centre (centre of field)
																					Pitch between field II and III
																					Length of field II and III
																					Width of field II and III
																					Length of field I
																					Width of field I
																					Length of image area
																					Width of image area
																					Length pitch of mounting holes
																					Width pitch of mounting holes
																					Diameter of mounting holes
																					Thickness of SolidStateMC at cable exit side
																					Thickness of SolidStateMC at image area
																					Length of SolidStateMC
																					Width of SolidStateMC

C=Carbon P=Phenolic

See Figure 4 *Mechanical Lay-out* on page 13 for description of reference letters.

2.8. Specifications

Description	Reference														
kV range	40 to 150kV														
X-ray attenuation. 99.9 % Al. purity.	Carbon < 0.9mm. at 70-90 kV and HVL 2.5-3.2 Al. Phenolic <0.9mm. at 70-90 kV and HVL 2.5-3.2 Al.														
Dose rate	20 µGy/s to 5000 µGy/s														
Reproducibility	0.02 Coefficient of variation														
Relative kV sensitivity	<table border="0"> <tr><td>40 kV</td><td>1.12</td></tr> <tr><td>50 kV</td><td>1.11</td></tr> <tr><td>60 kV</td><td>1.08</td></tr> <tr><td>80 kV</td><td>1.00</td></tr> <tr><td>100 kV</td><td>0.94</td></tr> <tr><td>120 kV</td><td>0.86</td></tr> <tr><td>140 kV</td><td>0.80</td></tr> </table>	40 kV	1.12	50 kV	1.11	60 kV	1.08	80 kV	1.00	100 kV	0.94	120 kV	0.86	140 kV	0.80
40 kV	1.12														
50 kV	1.11														
60 kV	1.08														
80 kV	1.00														
100 kV	0.94														
120 kV	0.86														
140 kV	0.80														
Reaction Time	≤ 1.6 ms.														
Sensitivity Tolerance	± 25% max. Between fields ±10% maximum difference.														
Materials	Carbon or Phenolic														
Application	Use as sensor in AEC circuits														
Weight	< 1.3 kg														
Operation environment	Ambient temperature: +10°C to +40°C Relative humidity: 35% to 85% non-condensing Atm. Pressure: 860hPa to 1060hPa														
Storage / Transport	Ambient temperature: -20°C to +60°C Relative humidity: 35% to 85% non-condensing Atm. Pressure: 860hPa to 1060hPa														
Acceleration / Shock	Maximum 10 G allowed from external conditions (e.g. during transport)														
Applicable standards	IEC60601-1 IEC60601-1-2 IEC60601-1-3 IEC60601-2-54														

3. Installation

	<p>NOTE: Allow the system to level with room temperature before installation.</p>
---	--

3.1. Installation requirements

	<p>WARNING: Installation and initial operation may only be carried out by an expert who has been trained in the field of medical diagnostic X-ray equipment.</p>
---	---

	<p>WARNING: Modifications to the product are not allowed.</p>
---	--

	<p>WARNING: Do not soak the device with liquids.</p>
---	---

3.2. Installation instructions

In the X-ray path, the position of the SolidStateMC is always between patient and image receptor. In case an anti-scatter grid is mounted, the SolidStateMC is installed between the anti-scatter grid and the image receptor.

Position the SolidStateMC in such a way that the centre aligns with the centre of the X-ray beam. The imprint on the SolidStateMC must be facing the X-ray tube.

Mechanical mounting must be done in such a way that the structural integrity is maintained.

Connect the SolidStateMC to the control electronics by means of a cable, see §1.7. The Connection diagram and plug pin lay-out of this cable are found under §5.3.1.

Correct functioning of the SolidStateMC is guaranteed only if the cable as well as the SolidStateMC shielding is properly connected.

Setting the sensitivity must be done by following the AEC check procedure of the X-ray system.

3.3. Necessary recurrent testing

	<p>WARNING: Before granting the automatic exposure control for the use on patients, check the functionality of all AEC fields with a phantom.</p>
---	--

4. Mains isolation

The SolidStateMC always needs to be connected to a host system that complies with the required regulations and standards.

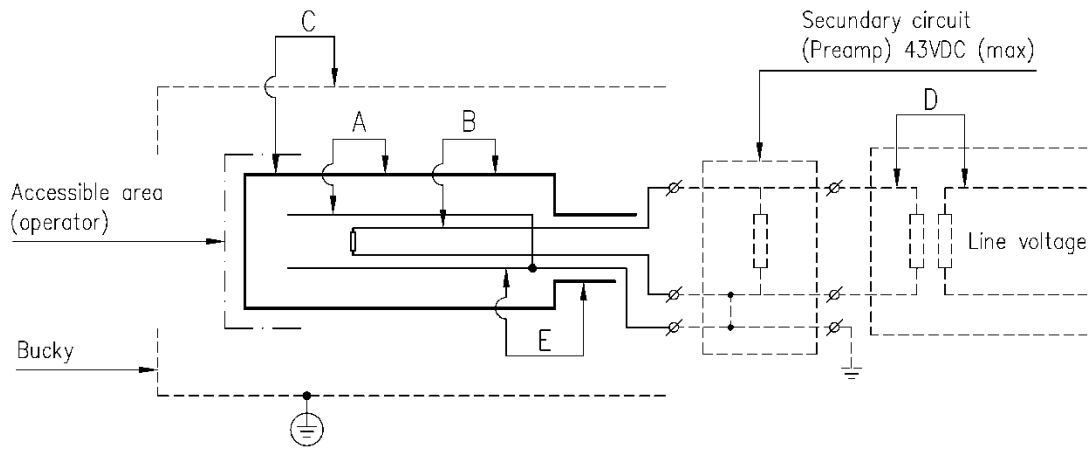

	Ref.	Insulation	Working voltage	Insulation test voltage
A	1	MOPP	43 VDC	500 VACrms
B	1	MOPP	43 VDC	500 VACrms
C	1	MOPP	43 VDC	See note 1
D	2	MOPP	Line Voltage	See note 1
E	1	MOPP	43 VDC	500 VACrms

Note 1: Out of product scope,

Figure 1 Means of protection

5. Service, maintenance and cleaning

Refer service to a qualified service technician only.

SolidStateMC's do not require any maintenance and will last during the lifetime of the X-ray system.

In case of malfunction of the AEC system, the SolidStateMC can be checked according to the described test procedure in §5.6.

5.1. Safety precautions

When there is structural damage to the housing or cable of the device, label the device as "out of order" and have the device repaired prior to further use.

5.2. Procedure at defects

- Exchange extension cable.
- Exchange SolidStateMC

5.3. Device Data

5.3.1. Connections

PIN	SIGNAL	COLOUR
1	Field 1 Anode	White
2	Field 2 Anode	Pink
3	Field 3 Anode	Green
4	Field 3 Cathode	Yellow
5	Field 2 Cathode	Grey
6	Field 1 Cathode	Brown
Shield	Functional Earth	

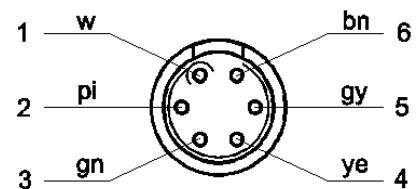

Figure 2 Connector lay-out solder side view

5.3.2. Equivalent schematic

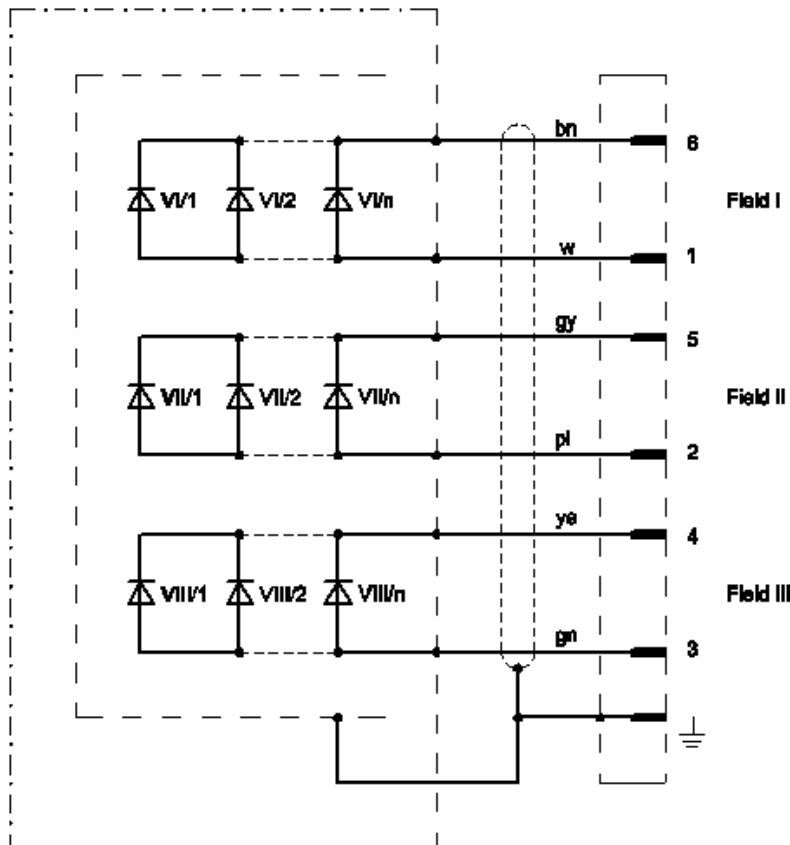

Figure 3 Equivalent Schematic

5.3.3. Lay-out of SolidStateMC

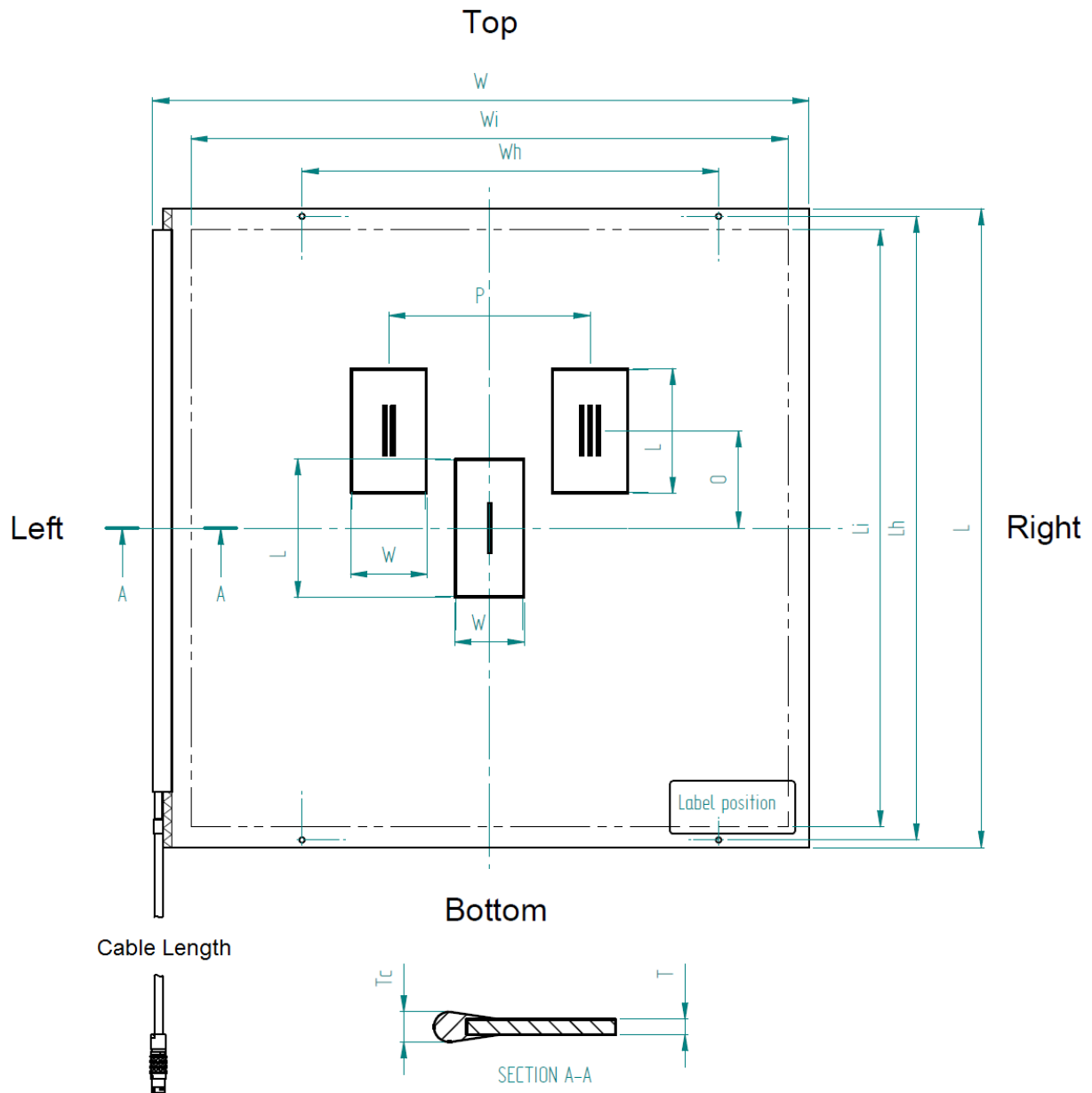

Figure 4 Mechanical Lay-out

5.4. Cleaning

Cleaning with a damp cloth is recommended. Use generally available alcohol-based cleaning agents.

5.5. Disinfection

Disinfection with a damp cloth with Isopropyl alcohol is recommended. Before using a disinfectant, check at a spot on the bottom of the device if the disinfectant will not damage the plastic and coated metal surfaces.

5.6. Test Procedure

5.6.1. Check-up on open contacts or short circuits

Check-up of the SolidStateMC and (extension) cable is done with a digital multi-meter, check for open contacts and short circuits.

The terminal arrangement is found in the schematic diagram, chapter 5.3.2, and connector pin lay-out 5.3.1.

Locate possible defects at SolidStateMC or extension cable by checking on the connector or, if applicable, on the connector at the electronic side of the extension cable.

5.6.2. Auxiliary measurement under radiation

Perform a separate measurement for each field of the SolidStateMC. Cover the SolidStateMC with shielding material except the field to be measured or limit the X-ray beam with a collimator to the measured field only.

The measurement is carried out as a voltage measurement.

Connect voltmeter (anode on +, cathode on -) and apply a load-resistance of 47K ohm.

Rejection limit:

If - under the same conditions – the measured voltage differ more than 30% from the recorded reference values, replace the SolidStateMC.

Typical value

The measured voltage depends on several factors. The following indication serves as typical value:

Tube voltage	40 kV
Tube current	100 mA
Distance focal spot –SolidStateMC	150 cm
HVL	1.8

Under these conditions the typical auxiliary voltage on the SolidStateMC is approx. The sensitivity value from Table 1 multiplied by 20 and expressed in mV.

6. Quality Assurance (QA)

A SolidStateMC is part of the X-ray systems performance requirements and the adjustment procedures for the complete X-ray system are mandatory.

There are no additional QA procedures for using the SolidStateMC.

7. Disposal, ESD and EMC compatibility

7.1. Disposal

This device contains substances that can be hazardous to the environment and care should be taken when disposed of.

The device is marked with the following symbol:







Follow local regulations regarding disposal of devices that contain electronic parts.

7.2. ESD

	<p>WARNING:</p> <p>The device contains sensitive electronics. Ensure that ESD protective measures are in place when the device is installed or serviced to prevent damage to the device.</p>
---	---

7.3. EMC compatibility

The device conforms to IEC 60601-1-2:2014 for EMC compatibility and must be installed and put into service according to the EMC information provided in this manual.

	<p>WARNING:</p> <p>Portable RF communications equipment (including peripherals such as antenna cables and external antennas) should be used no closer than 30 cm (12 inches) to any part of the SolidStateMC 3 field, including cables specified by the manufacturer. Otherwise, degradation of the performance of this equipment could result.</p>
	<p>WARNING:</p> <p>Not taking EMC measures into account on the wiring may result in increased EMISSIONS or decreased IMMUNITY. IEC 60601-1-2:2014 must be followed for being complaint with EMC guidelines.</p>
	<p>WARNING:</p> <p>Use of this equipment adjacent to or stacked with other equipment should be avoided because it could result in improper operation. If such use is necessary, this equipment and the other equipment should be observed to verify that they are operating normally.</p>
	<p>WARNING:</p> <p>Use of accessories, transducers and cables other than those specified or provided by the manufacturer of this equipment could result in increased Electromagnetic emissions or decreased Electromagnetic immunity of this equipment and result in improper operation.</p>
	<p>NOTE:</p> <p>The EMISSIONS characteristics of this equipment make it suitable for use in industrial areas and hospitals (CISPR 11 class A). If it is used in a residential environment (for which CISPR 11 class B is normally required) this equipment might not offer adequate protection to radio-frequency communication services. The user might need to take mitigation measures, such as relocating or re-orienting the equipment.</p>

7.3.1. Deviations

No deviations from IEC60601-1-2:2014 are applied.

7.3.2. Allowances

No allowances from IEC60601-1-2:2014 are used.

7.3.3. Precautions

Precautions to be taken to prevent adverse events to the PATIENT and the OPERATOR due to Electromagnetic Disturbances are listed in the column “Electromagnetic environment – guidance” in the tables below.

7.3.4. Emissions Compliance

Guidance and manufacturer’s declaration – Electromagnetic emissions		
The SolidStateMC 3 field is intended for use in the Electromagnetic environment specified below. The customer or user of the SolidStateMC 3 field should assure that it is used in such an environment.		
Emissions test	Compliance	Electromagnetic environment - guidance
RF emissions group CISPR 11	Group 1	The SolidStateMC 3 field uses RF energy only for its internal function. Therefore, its RF emissions are very low and are not likely to cause any interference in nearby electronic equipment.
RF emissions class CISPR 11	Class A	The EMISSIONS characteristics of SolidStateMC 3 field make it suitable for use in industrial areas and hospitals (CISPR 11 class A). If it is used in a residential environment (for which CISPR 11 class B is normally required) this equipment might not offer adequate protection to radio-frequency communication services. The user might need to take mitigation measures, such as relocating or re-orienting the equipment.”
Harmonic emissions IEC 61000-3-2	Not Applicable	
Voltage fluctuations/ flicker emissions IEC 61000-3-3	Not Applicable	

7.3.5. Immunity Compliance

Guidance and manufacturer’s declaration – Electromagnetic immunity – ENCLOSURE PORT		
The SolidStateMC 3 field is intended for use in the Electromagnetic environment specified below. The customer or user of the SolidStateMC 3 field should assure that it is used in such an environment.		
Immunity test	Compliance Test level	Electromagnetic environment – guidance
Electrostatic discharge (ESD) IEC 61000-4-2	± 8 kV contact ± 2 kV, ± 4 kV, ± 8 kV, ± 15 kV air	Floors should be wood, concrete or ceramic tile. If floors are covered with synthetic material, the relative humidity should be at least 30 %.
Proximity fields from RF wireless communications equipment IEC 61000-4-3	See next table below	Portable RF communications equipment (including peripherals such as antenna cables and external antennas) should be used no closer than 30 cm (12 inches)
Power frequency (50/60 Hz) magnetic field IEC 61000-4-8	Not Applicable	Power frequency magnetic fields should be at levels characteristic of a typical location in a typical commercial or hospital environment.

Guidance and manufacturer's declaration – Electromagnetic immunity – Compliance Test Levels for ENCLOSURE PORT IMMUNITY to RF wireless communications equipment						
Test frequency (MHz)	Band (MHz)	Service ^{a)}	Modulation	Maximum power (W)	Distance (m)	IMMUNITY TEST LEVEL (V/m)
385	380 – 390	TETRA 400	Pulse modulation ^{b)} 18 Hz	1,8	0,3	27
450	430 – 470	GMRS 460; FRS 460	FM ± 5 kHz deviation 1 kHz sine	2	0,3	28
710	704 – 787	LTE Band 13, 17	Pulse Modulation ^{b)}	0,2	0,3	9
745						
780			217 Hz			
810	800 – 960	GMS 800/900; TETRA 800; iDEN 820; CDMA 850; LTE Band 5	Pulse Modulation ^{b)}	2	0,3	28
870						
930			18 Hz			
1 720	1 700 – 1 990	GSM 1800; CDMA 1900; GSM 1900; DECT; LTE Band 1, 3, 4, 25; UMTS	Pulse Modulation ^{b)}	2	0,3	28
1 845						
1 970			217 Hz			
2 450	2 400 – 2 570	Bluetooth; WLAN 802.11 b/g/n; RFID 2450; LTE Band 7	Pulse Modulation ^{b)} 217 Hz	2	0,3	28
5 240	5 100 – 5 800	WLAN 802.11 a/n	Pulse Modulation ^{b)}	0,2	0,3	9
5 500						
5 785			217 Hz			

^{a)} For some services, only the uplink frequencies are included.
^{b)} The carrier is modulated using a 50 % duty cycle square wave signal.

Guidance and manufacturer's declaration – Electromagnetic immunity – Power and Signal PORTs		
The SolidStateMC 3 field is intended for use in the Electromagnetic environment specified below. The customer or user of the SolidStateMC 3 field should assure that it is used in such an environment.		
Immunity test	Compliance Test level	Electromagnetic environment – guidance
Electrostatic discharge (ESD) IEC 61000-4-2	± 8 kV contact ± 2 kV, ± 4 kV, ± 8 kV, ± 15 kV air	Floors should be wood, concrete or ceramic tile. If floors are covered with synthetic material, the relative humidity should be at least 30 %.
Electrical fast transient/burst IEC 61000-4-4	± 2 kV AC and DC power ports ± 1 kV signal ports 100kHz repetition frequency	Mains power quality should be that of a typical commercial or hospital environment.
Surges Line-to-line IEC 61000-4-5	Not Applicable	The SolidStateMC 3 field is intended to be supplied by a secondary IEC60601-1 compliant AC or DC power supply.
Surges Line-to-ground IEC 61000-4-5	Not Applicable	
Conducted disturbances induced by RF fields IEC 61000-4-6	3 V ^{a)} 0,15 MHz – 80 Mhz 6 V ^{a)} in ISM bands between 0,15 MHz and 80 MHz ^{b)} 80 % AM at 1 kHz	Field strengths from fixed RF transmitters, as determined by an Electromagnetic site survey ^{c)} , should be less than the compliance level in each frequency range. Interference may occur near equipment marked with the following symbol: 
Voltage dips IEC 61000-4-11	Not Applicable	The SolidStateMC 3 field is intended to be supplied by a secondary IEC60601-1 compliant AC or DC power supply.
Voltage interruptions IEC 61000-4-11	Not Applicable	
<p>^{a)} r.m.s. before modulation is applied</p> <p>^{b)} The ISM (industrial, scientific and medical) bands between 150 kHz and 80 MHz are 6,765 MHz to 6,795 MHz; 13,553 MHz to 13,567 MHz; 26,957 MHz to 27,283 MHz; and 40,66 MHz to 40,70 MHz. The amateur radio bands between 0,15 MHz and 80 MHz are 1,8 MHz to 2,0 MHz, 3,5 MHz to 4,0 MHz, 5,3 MHz to 5,4 MHz, 7 MHz to 7,3 MHz, 10,1 MHz to 10,15 MHz, 14 MHz to 14,2 MHz, 18,07 MHz to 18,17 MHz, 21,0 MHz to 21,4 MHz, 24,89 MHz to 24,99 MHz, 28,0 MHz to 29,7 MHz and 50,0 MHz to 54,0 MHz.</p> <p>^{c)} Field strengths from fixed transmitters, such as base stations for radio (cellular/cordless) telephones and land mobile radios, amateur radio, AM and FM radio broadcast and TV broadcast cannot be predicted theoretically with accuracy. To assess the Electromagnetic environment due to fixed RF transmitters, an Electromagnetic site survey should be considered. If the measured field strength in the location in which the SolidStateMC 3 field is used exceeds the applicable RF compliance level above, the SolidStateMC 3 field should be observed to verify normal operation. If abnormal performance is observed, additional measures may be necessary, such as re-orienting or relocating the SolidStateMC 3 field.</p>		
<p>NOTE</p> <p>These guidelines may not apply in all situations. Electromagnetic propagation is affected by absorption and reflection from structures, objects and people</p>		



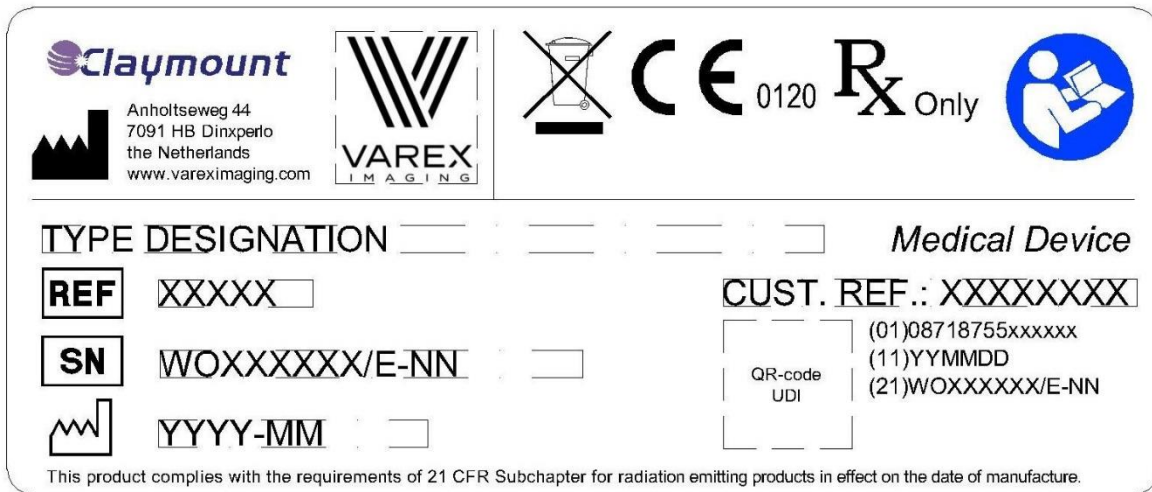

8. Product label and symbols on the device

8.1. Product label

The product label can be found at the lower right-hand side of the SolidStateMC.



8.2. Symbols on the device

Symbol	Explanation
	Manufacturer
	Date of manufacture
REF	Catalogue number
SN	Serial number
CE 0120	CE-mark directive 93/42/EC; conformity assessment by notified body 0120
	Follow the instructions for use Reading the instructions for use is mandatory for a correct and safe operation of the SolidStateMC
	Identification of compliance with the provisions for EU WEEE directive
Rx Only	For professional use only
FCC	Identification of compliance with FCC 47 CFR Part 15 (optional feature)

Contact details

Varex Imaging Nederland B.V.

The Netherlands

t +31 315 659 150

f +31 315 659 140

Netherlands.CNC@vareximaging.com

Varex Imaging Americas Corp.

U.S.A.

t +1 847 279 5100

f +1 630 271 9995

Americas.CNC@vareximaging.com

Varex Imaging Philippines Inc.

Philippines

t +63 49 5024 520

t +63 49 5024 521

f +63 49 5024 500

f +63 2 8076 472

Philippines.CNC@vareximaging.com

Varex Imaging Technology (Beijing) Co., Ltd.

China

t +86 10 6780 2708

t +86 10 6780 2129

f +86 10 6780 2170

China.CNC@vareximaging.com

© 2019 by Varex Imaging Nederland B.V.

All Rights reserved. No part of this document may be reproduced or transmitted in any form or by any means, electronic, mechanical, photocopying, recording, or otherwise, without prior written permission of Varex Imaging Nederland B.V.